

Einzelteile der Lokomotive 37157

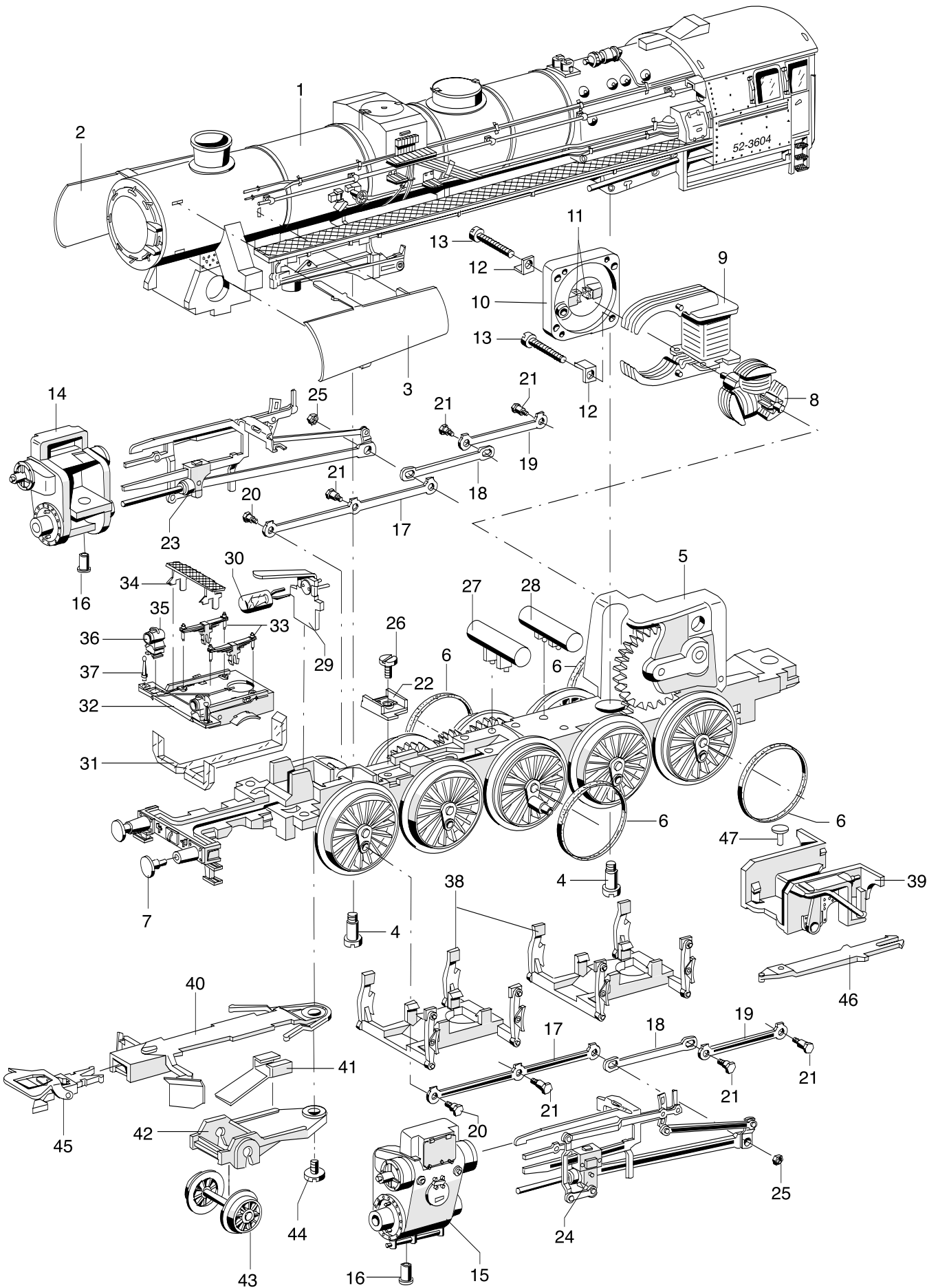

Einzelteile der Lokomotive 37157

