

märklin

Z

Modell der

BR 185 / BR 482

88482

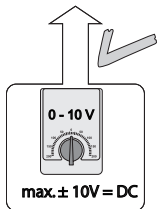

max. $\pm 10V = DC$

67011
67020 + 67030
67201
67271

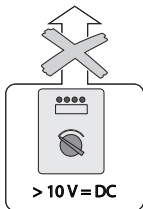

$> 10V = DC$

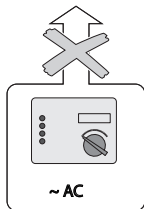

$\sim AC$

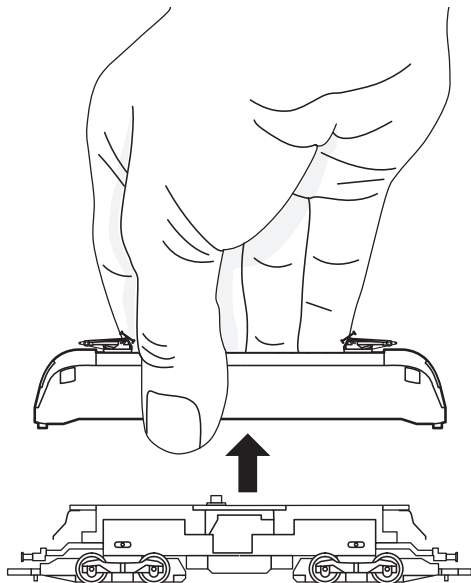

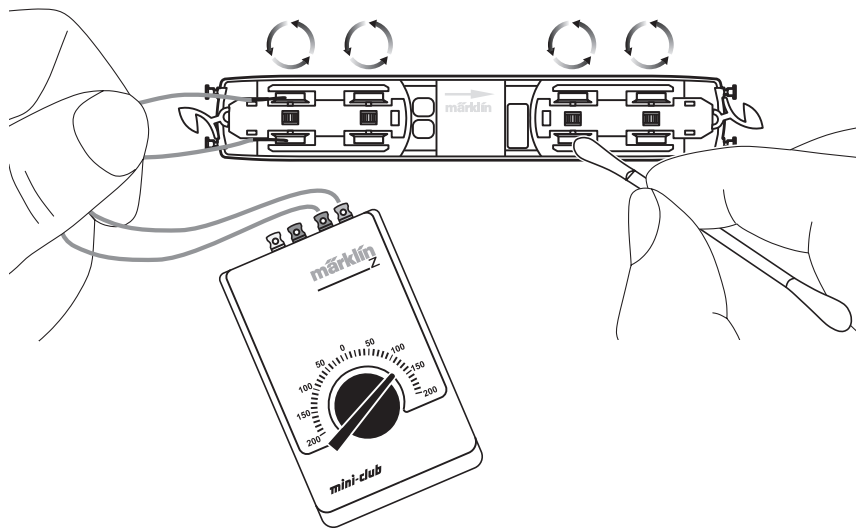

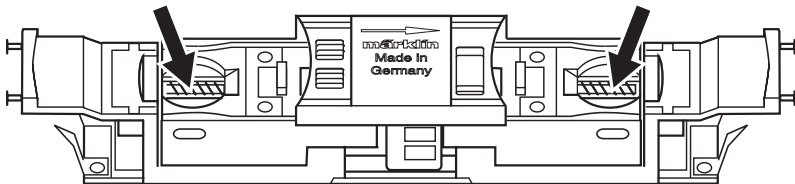
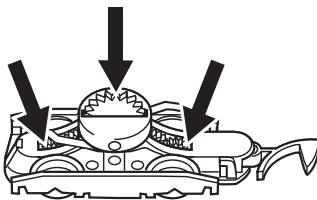
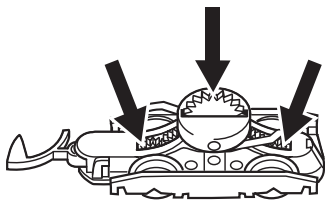
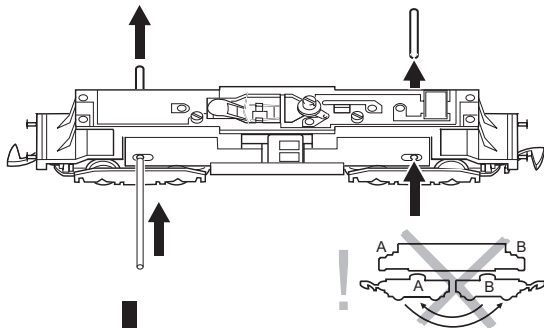
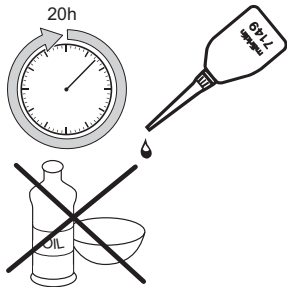

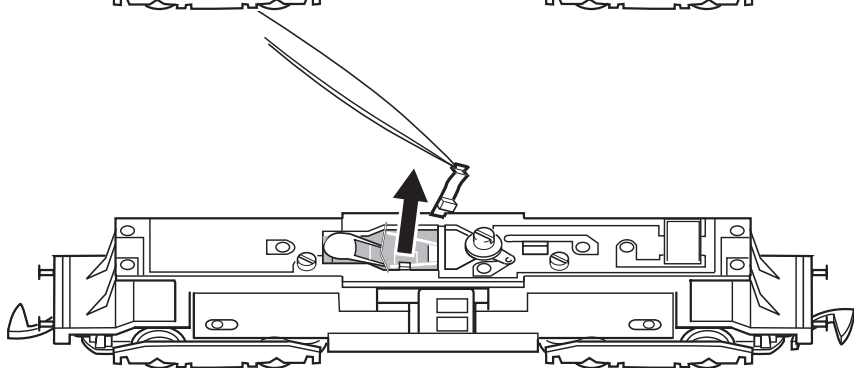
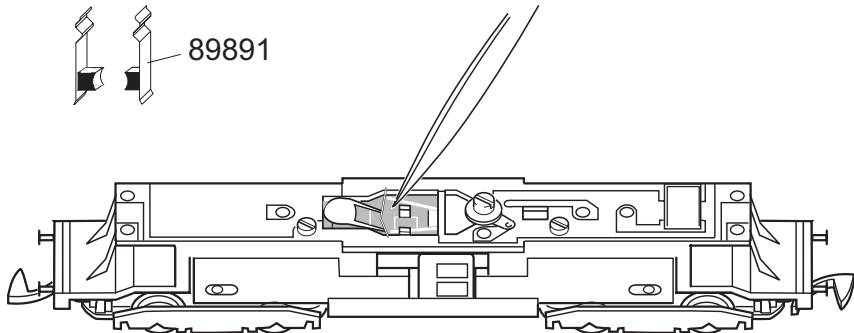
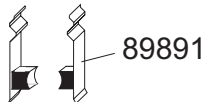

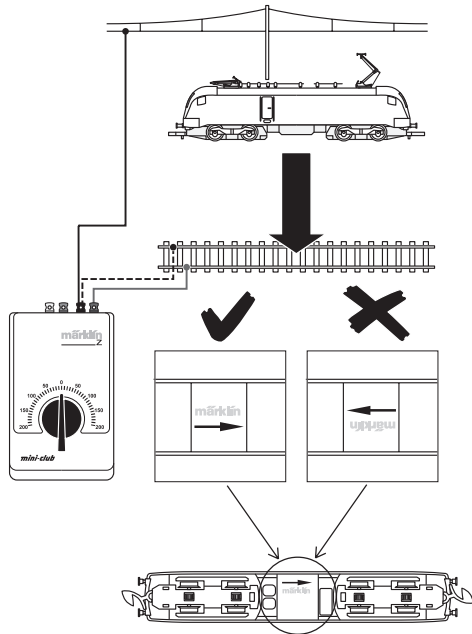
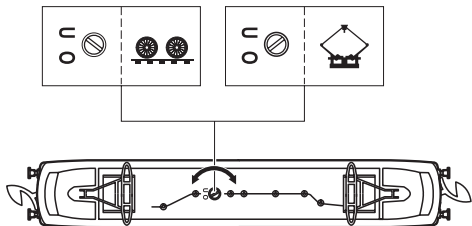

Bei Oberleitungsbetrieb Pfeil beachten!

To operate the catenary system follow the direction indicated by the arrow.

Pour utilisation de la caténaire tenir compte de la flèche.

Bij gebruik van bovenleiding op pijl letten!

Al funcionar con catenaria obsérvese la flecha.

Per esercizio tramite la catenaria osservare la freccia.

Vid kontaktledningsdrift observera pilen.

Ved luftledningsdrift, bemærk pil.

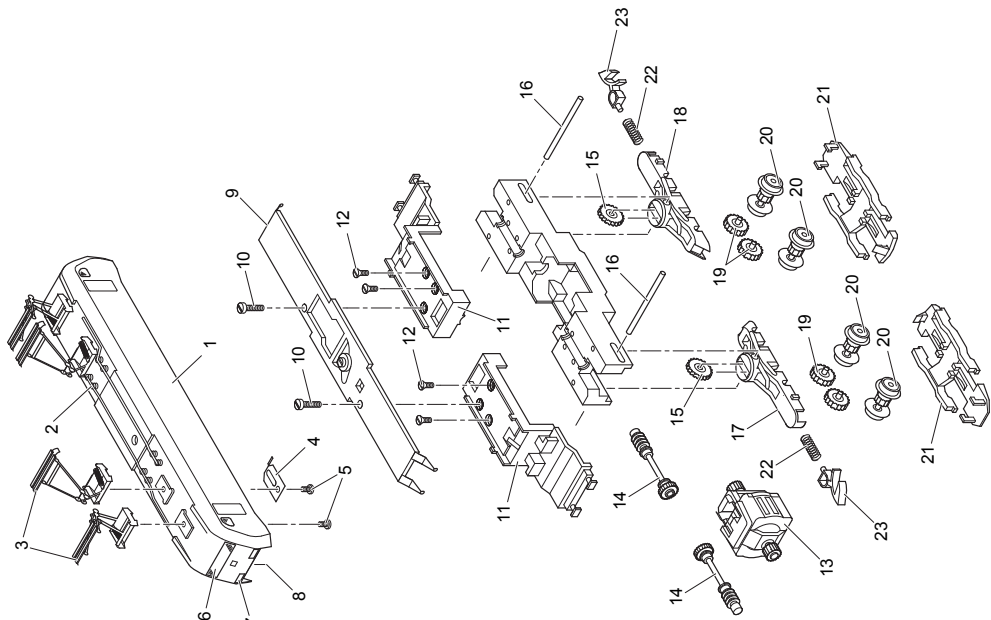

1	Aufbau	103 014	9	Leiterplatte	485 660
2	Dachleitung mit Isolatoren	103 016	10	Zylinderschraube	785 190
3	Dachstromabnehmer	209 286	11	Isolierung	217 368
4	Kontaktfeder	268 100	12	Senkschraube	785 550
5	Zylinderschraube	785 150	13	Motor	211 903
6	Fenstereinsätze	116 284	14	Antriebswelle	265 250
7	Beleuchtungseinheit	103 010	15	Zahnrad	262 960
8	Lichtabdeckung	103 007	16	Achse	260 720
			17	Getriebegehäuse vorn	218 315
			18	Getriebegehäuse hinten	218 317
			19	Zwischenradsatz	260 920
			20	Treibradsatz	216 476
			21	Drehgestellrahmen	218 328
			22	Druckfeder	765 680
			23	Kupplungshaken	704 200