

märklin
Z



mini-club

Modell der BR 38 / P8

88998

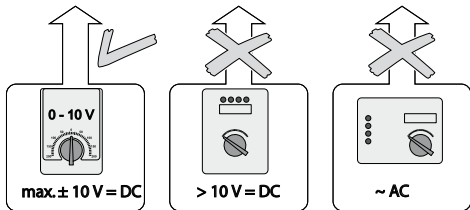

67011

67020 + 67030

67201

67271

Sicherheitshinweise

- **ACHTUNG!** Funktionsbedingte scharfe Kanten und Spitzen.
- Das verwendete Gleisanschlusskabel darf maximal 2 Meter lang sein.

Safety Notes

- **WARNING!** Sharp edges and points required for operation.
- The wire used for feeder connections to the track may be a maximum of 2 meters / 78 inches long.

Remarques importantes sur la sécurité

- **ATTENTION !** Pointes et bords coupants lors du fonctionnement du produit.
- Le câble de raccordement à la voie utilisé ne doit en aucun cas dépasser deux mètres.

Veiligheidsvoorschriften

- **OPGEPAST!** Functionele scherpe kanten en punten.
- De gebruikte aansluitkabel mag maximaal 2 meter lang zijn.

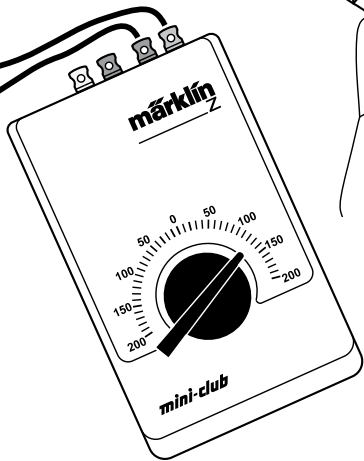
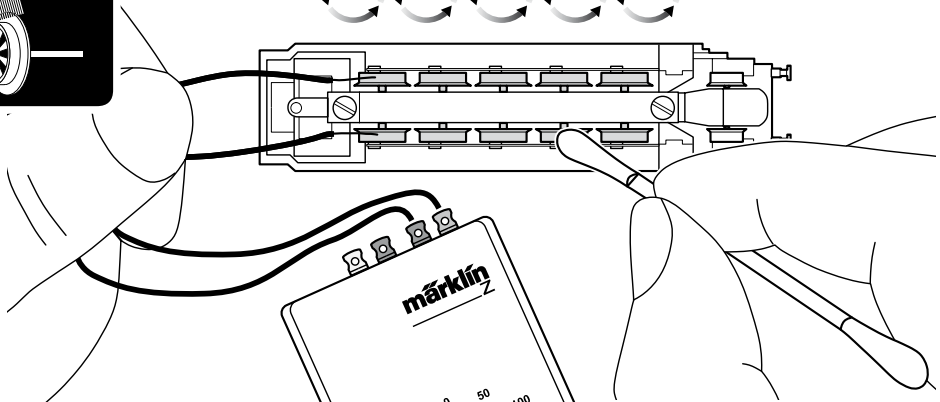
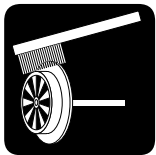

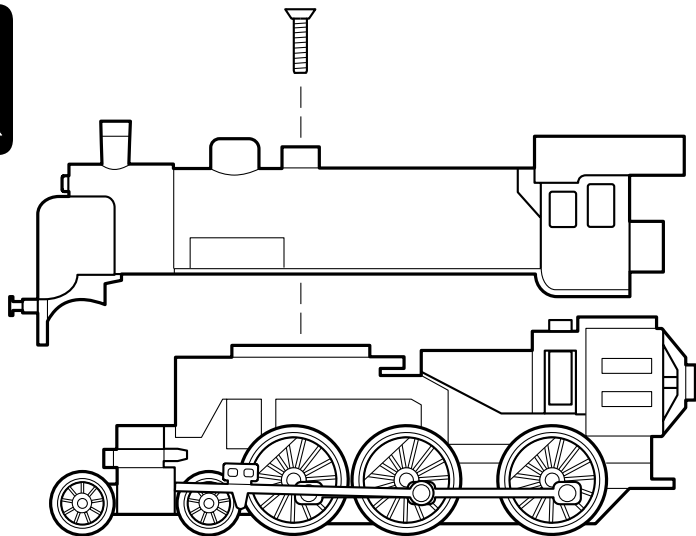

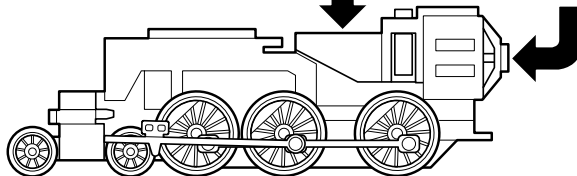
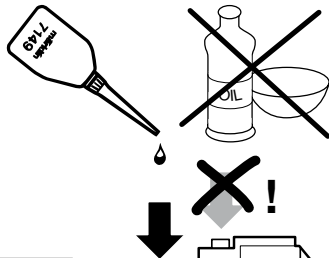

- Nur sparsam ölen (max. 1 Tropfen). Zuviel Öl führt häufig zum Verschmieren der Kollektoren und damit zur Beschädigung des Ankers.
- Oil sparingly (max. 1 drop). Too much oil frequently causes the commutator to become dirty and thereby leads to damage to the armature.
- Lubrifiez en très petite quantité (1 goutte max.). Trop d'huile entraîne souvent l'encrassement du collecteur et à des dommages à l'induit.
- Slechts spaarzaam oliën (max. 1 druppel). Te veel olie leidt vaak tot versmeren van de collector en daarmee tot beschadiging van het anker.

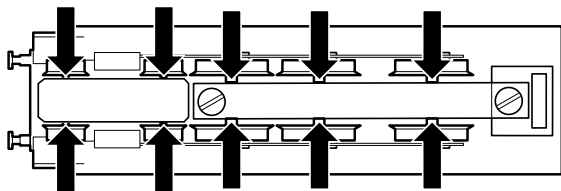

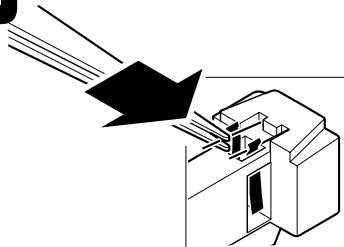
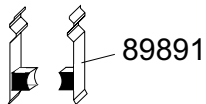
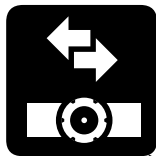

1

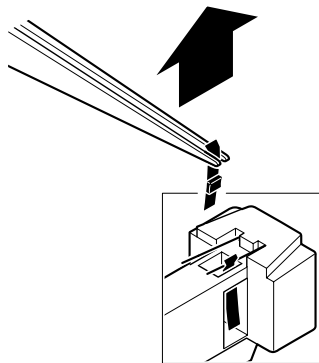

2

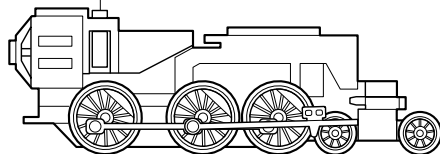

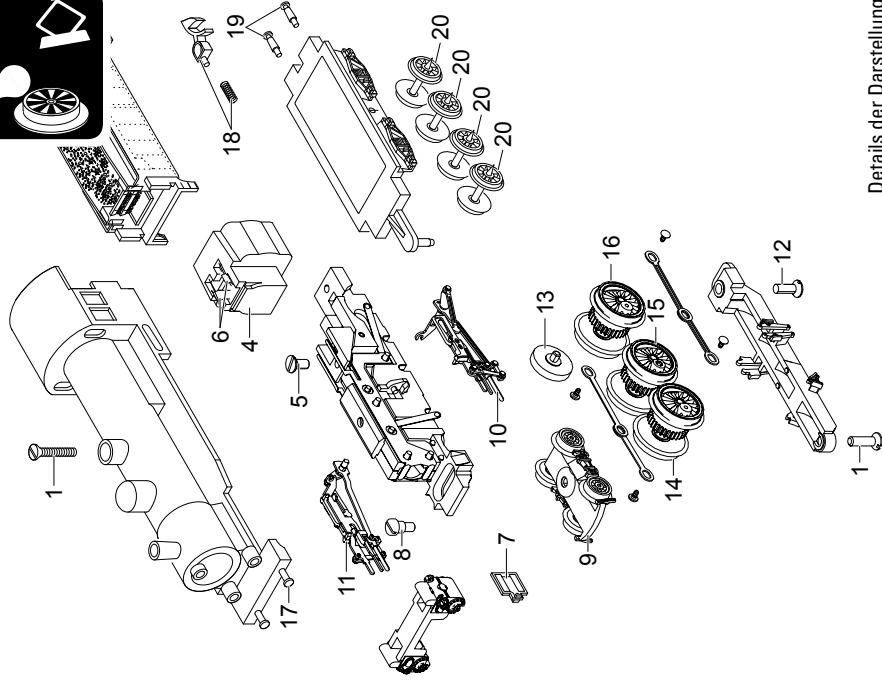

Details der Darstellung
können von dem Modell
abweichen.

1	Schraube	E785 570
	Windleitbleche	E185 764
	Pumpe, Lichtmaschine	E179 838
4	Motor	E211 912
5	Schraube	E785 550
6	Motorbürsten	89 891
7	Beleuchtungseinheit	E181 572
8	Schraube	E753 130
9	Drehgestell	E181 596
10	Gestänge rechts	E191 615
11	Gestänge links	E191 629
12	Schraube	E785 580
13	Zwischenradsatz	E221 807
14	Treibradsatz	E191 613
15	Treibradsatz	E191 610
16	Treibradsatz	E191 614
17	Puffer	E761 480
18	Kupplung	E166 264
19	Puffer	E167 989
20	Radsatz	E215 721

Gebr. Märklin & Cie. GmbH
 Stuttgarter Str. 55 - 57
 73033 Göppingen
 Germany
www.maerklin.com



www.maerklin.com/en/imprint.html

227597/1013/Sm1Ef
 Änderungen vorbehalten
 © Gebr. Märklin & Cie. GmbH