

märklin
Z

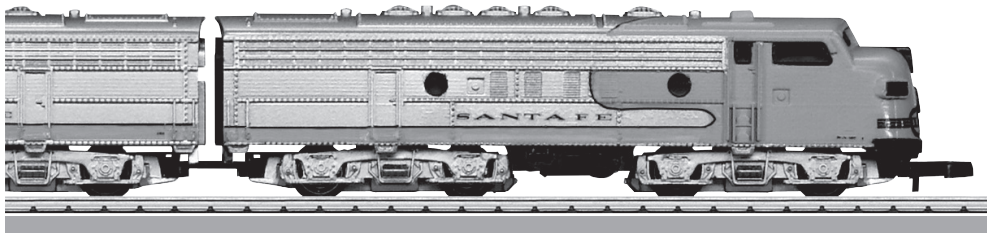

Modell der Diesellok F7
88190

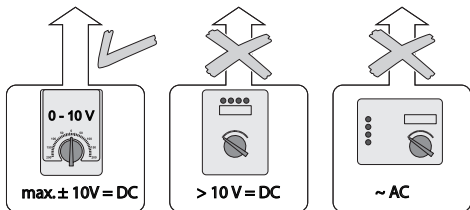

max. $\pm 10V = DC$

$> 10V = DC$

$\sim AC$

67011
67020 + 67030
67201
67271

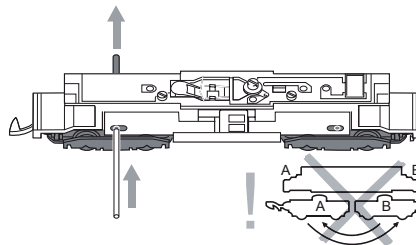
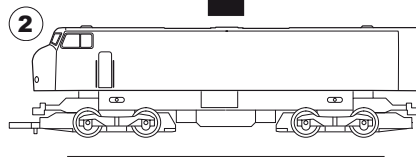
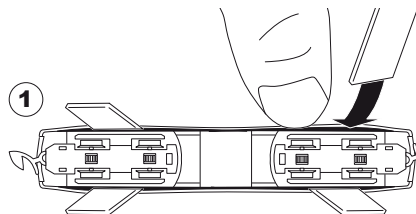

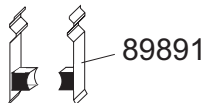

89891

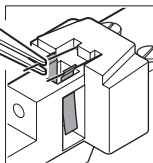
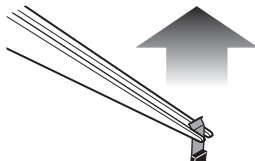

1

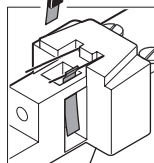

2

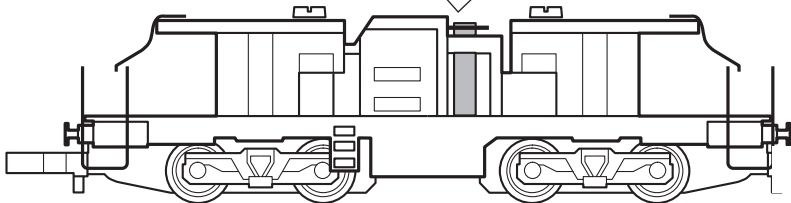

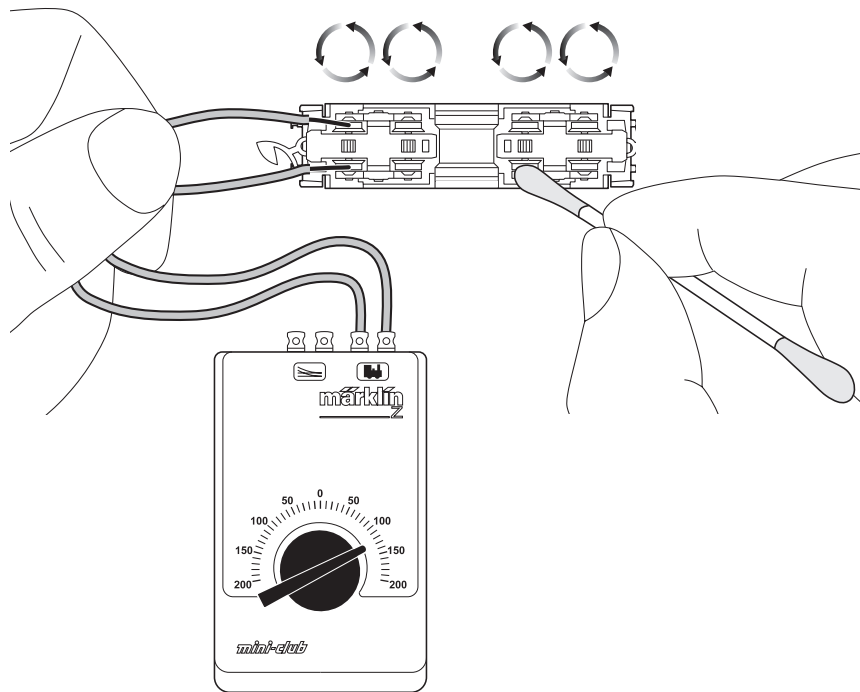

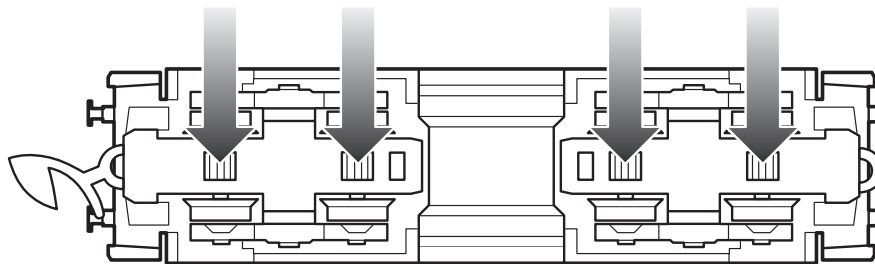
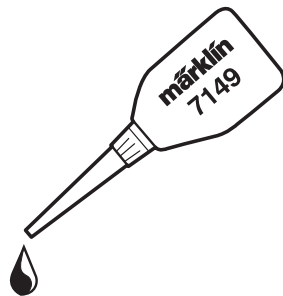
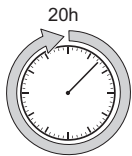

- Das verwendete Gleisanschlusskabel darf maximal 2 Meter lang sein.
- **ACHTUNG!** Funktionsbedingte scharfe Kanten und Spitzen.
- The wire used for feeder connections to the track may only be a maximum of 2 meters / 39 inches long.
- **WARNING!** Sharp edges and points required for operation.
- Le câble de raccordement à la voie utilisé ne doit en aucun cas dépasser deux mètres.
- **ATTENTION!** Pointes et bords coupants lors du fonctionnement du produit.
- De gebruikte aansluitkabel mag maximaal 2 meter lang zijn.
- **OPGEPAST!** Functionele scherpe kanten en punten.

Lfd. Nr.	Benennung	Bestell-Nr.
1	Zylinderschraube	785 190
2	Leiterplatte	268 730
3	Senkschraube	785 550
4	Beleuchtung	8 953
5	Motor	211 903
6	Antriebswelle	263 020
7	Drehgestell vorne	167 858
8	Drehgestell hinten	167 859
9	Kupplung komplett	E166 264
10	Kuppelstange	E436 340

Hinweis: Einige Teile werden nur ohne oder mit anderer Farbgebung angeboten.
Teile, die hier nicht aufgeführt sind, können nur im Rahmen einer Reparatur im Märklin Reparatur-Service repariert werden.

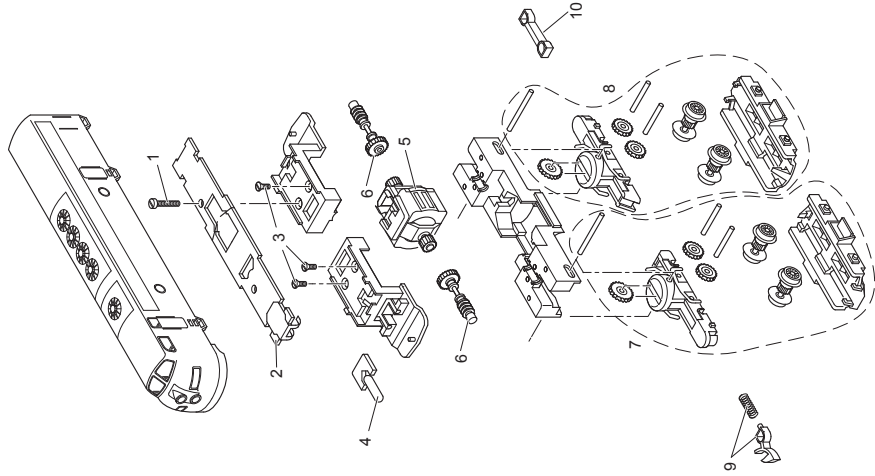

Details der Darstellung können von dem Modell abweichen.

Gebr. Märklin & Cie. GmbH
Stuttgarter Str. 55 - 57
73033 Göppingen
Deutschland
www.maerklin.com

122411/1211/Ha2Ef
Änderungen vorbehalten
© Gebr. Märklin & Cie. GmbH