

**märklin**  
Z



***mini-club***

Modell der BR 38 / P8

**88999**

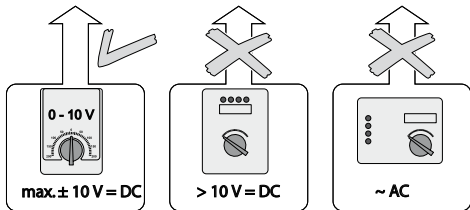

67011

67020 + 67030

67201

67271

### Sicherheitshinweise

- **ACHTUNG!** Funktionsbedingte scharfe Kanten und Spitzen.
- Das verwendete Gleisanschlusskabel darf maximal 2 Meter lang sein.

### Safety Notes

- **WARNING!** Sharp edges and points required for operation.
- The wire used for feeder connections to the track may be a maximum of 2 meters / 78 inches long.

### Remarques importantes sur la sécurité

- **ATTENTION !** Pointes et bords coupants lors du fonctionnement du produit.
- Le câble de raccordement à la voie utilisé ne doit en aucun cas dépasser deux mètres.

### Veiligheidsvoorschriften

- **OPGEPAST!** Functionele scherpe kanten en punten.
- De gebruikte aansluitkabel mag maximaal 2 meter lang zijn.

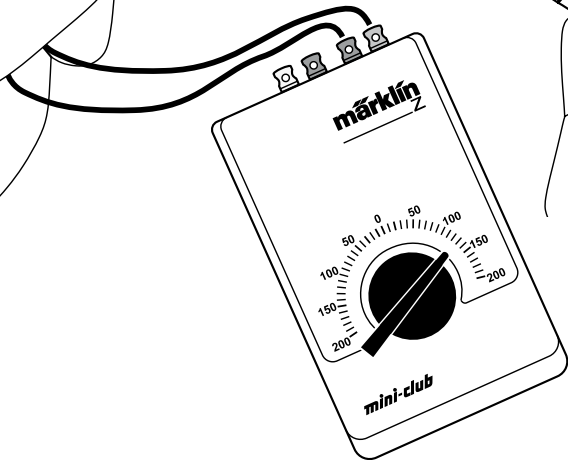
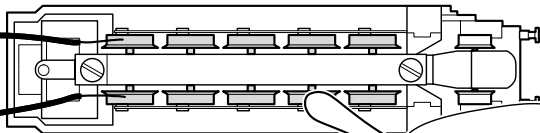
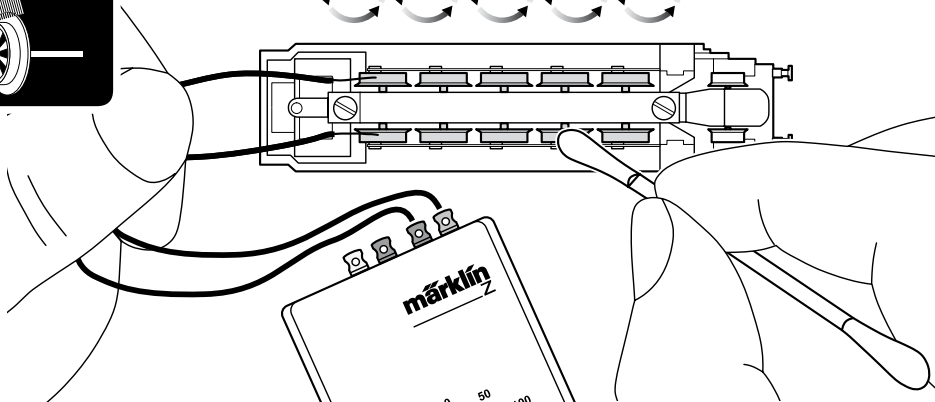
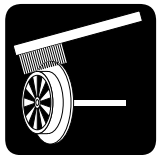

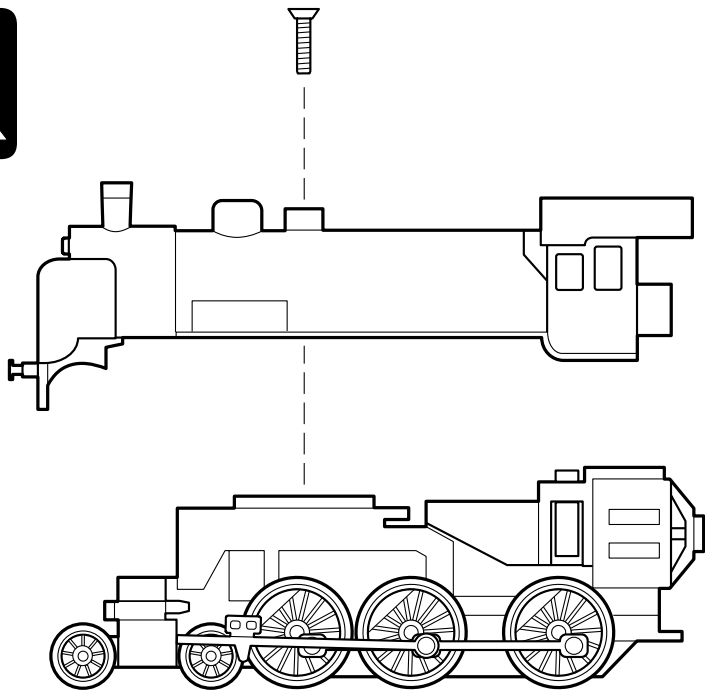

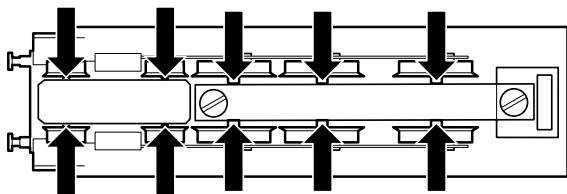
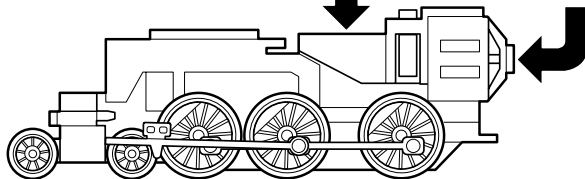
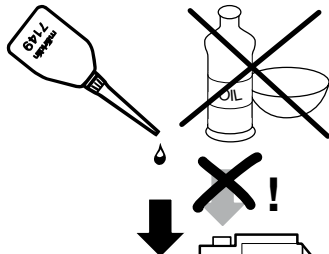

- Nur sparsam ölen (max. 1 Tropfen). Zuviel Öl führt häufig zum Verschmieren der Kollektoren und damit zur Beschädigung des Ankers.
- Oil sparingly (max. 1 drop). Too much oil frequently causes the commutator to become dirty and thereby leads to damage to the armature.
- Lubrifiez en très petite quantité (1 goutte max.). Trop d'huile entraîne souvent l'encrassement du collecteur et à des dommages à l'induit.
- Slechts spaarzaam oliën (max. 1 druppel). Te veel olie leidt vaak tot versmeren van de collector en daarmee tot beschadiging van het anker.

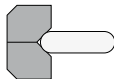
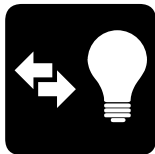

8953

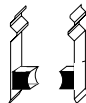
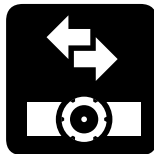
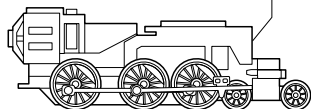
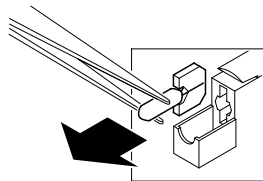

89891

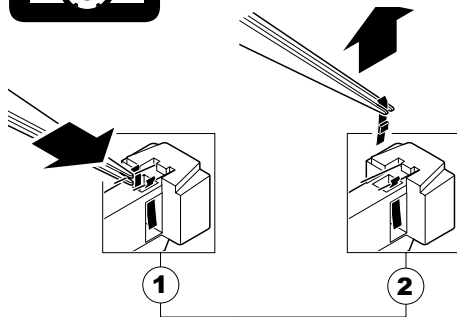

1

2

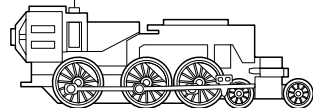

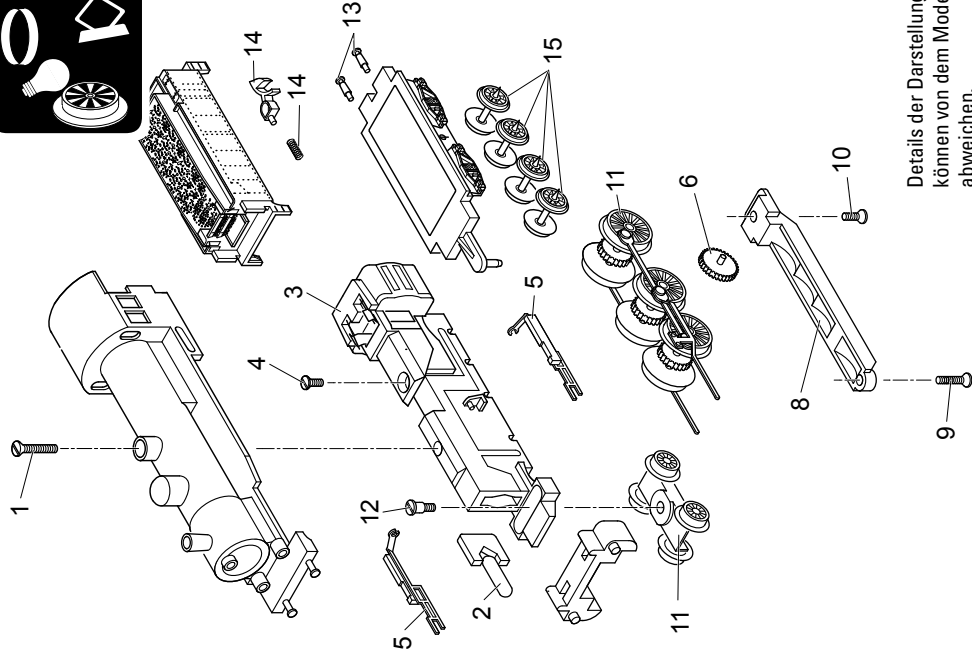

Details der Darstellung  
können von dem Modell  
abweichen.

1	Schraube	E785 570
2	Beleuchtungseinheit	8 953
3	Motor	E211 912
4	Schraube	E785 550
5	Kreuzkopfführung rechts & links	E181 202
6	Zwischenradsatz	E265 930
7	Treibradsatz mit Gestänge	E221 808
8	Abdeckung	E266 010
9	Schraube	E785 570
10	Schraube	E785 580
11	Drehgestell	E223 557
12	Schraube	E753 130
13	Puffer	E761 450
14	Kupplung	E166 264
15	Radsatz	E223 562

Gebr. Märklin & Cie. GmbH  
 Stuttgarter Str. 55 - 57  
 73033 Göppingen  
 Deutschland  
[www.maerklin.com](http://www.maerklin.com)



[www.maerklin.com/en/imprint.html](http://www.maerklin.com/en/imprint.html)

152332/0512/Sm2Ef  
 Änderungen vorbehalten  
 © Gebr. Märklin & Cie. GmbH